

Cross border digital signature in company registration portal

Ingmar Vali

ingmar.vali@just.ee

www.rik.ee



Topics



Company Registration Portal and PKI, eID



Cross border digital signature

- Implementation problems
- Future services

New company in 18 minutes

90 % of Estonians have ID-card

ID-card enables e-Signature

ID-card uses PKI



Internet connection

ID-card reader

Valid ID-card and PIN passwords

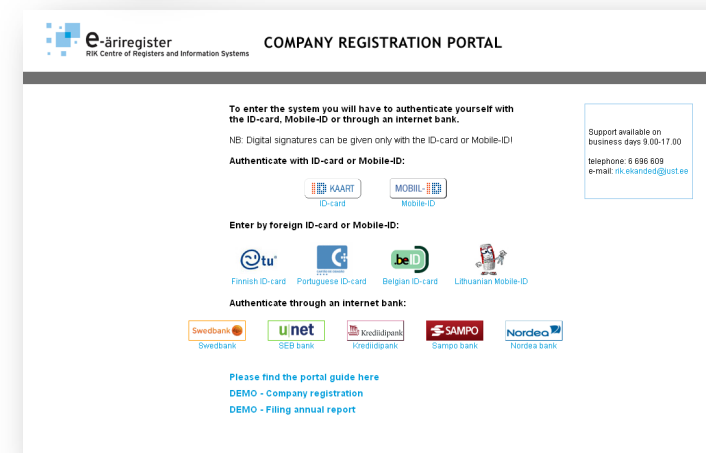

Company registration process

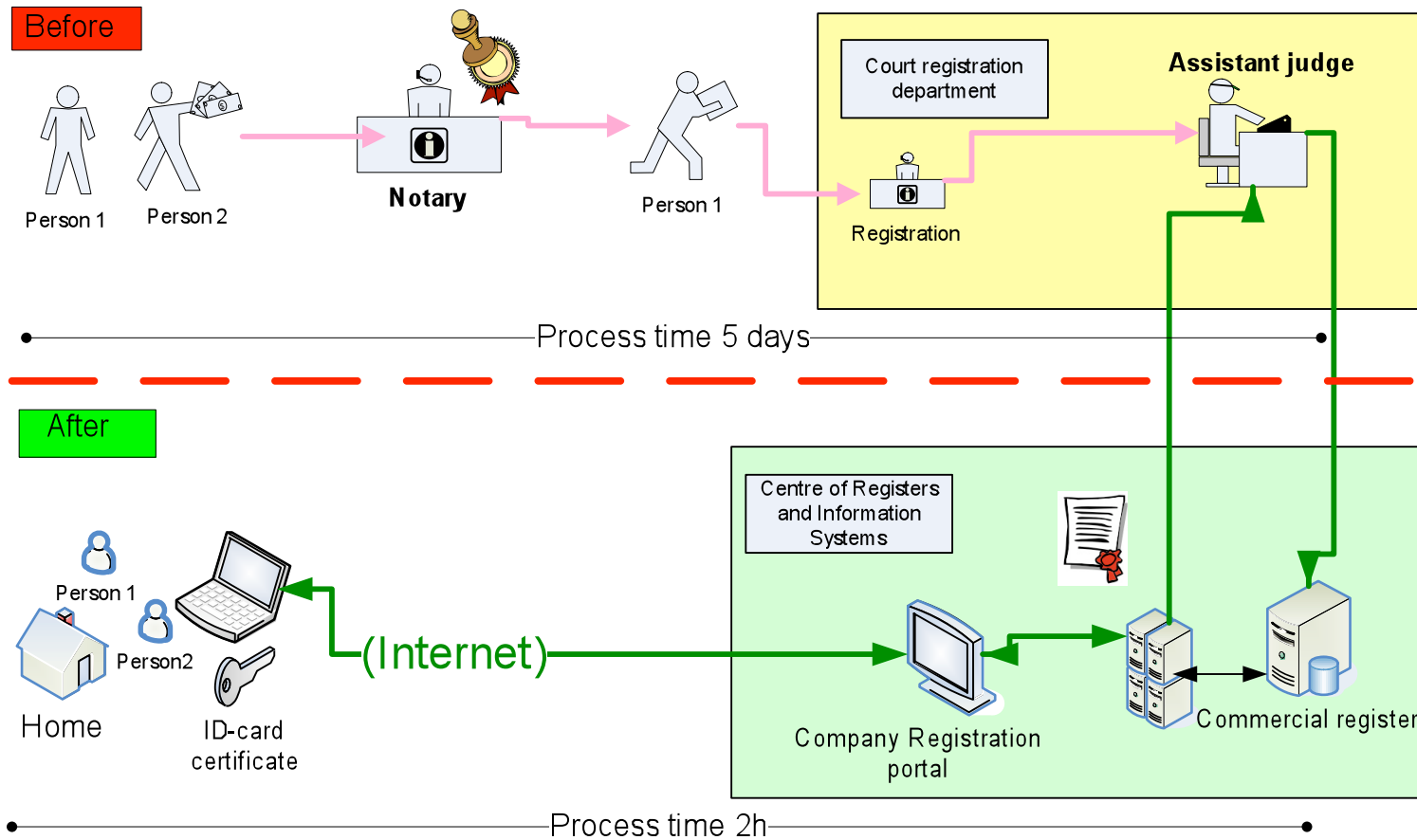

Company Registration Portal

Easy step by step process
to register a new company

No need for Public Notary

No paperwork at all

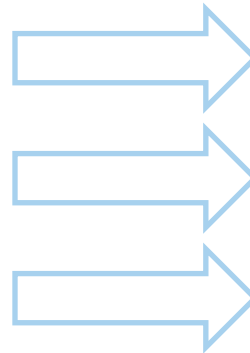

In portal you can:

- Register a new Company
- Change information in Business Register
- File annual report

The screenshot shows the 'COMPANY REGISTRATION PORTAL' interface. At the top, it displays the 'e-äriregister' logo and the 'RIK Centre of Registers and Information Systems'. The main navigation bar includes links for 'Opening page', 'Petitions for entries regarding alteration', 'Petitions for an initial entry', 'Filing of annual reports', 'Submission of the means of communication', and 'Notification of an activity'. Below this, a progress indicator shows the current step: 'Preparation of the entry petition'. The form is divided into several sections:

- Trader:** Includes fields for 'Business name' and 'Address'.
- Capital:** Includes fields for 'Share capital' and 'Foreign currency'.
- Persons in the entry:** A table with columns for 'Function', 'Code / Date of birth', 'Name / business name', 'Place of residence / seat', and 'Contribution'.
- Normal regulation of the right of representation:** A text area for 'The member of the management board' and 'The procurator'.
- Specifications of the right of representation:** A table with columns for 'Type' and 'Contents'.
- Legal form:** A dropdown menu for 'Private limited company'.
- Financial year:** Fields for 'Start of a financial year' and 'End of a financial year'.
- Articles of association:** A table with columns for 'Date of approval', 'Date of alteration', 'Explanation', and 'PDF document'.
- Persons outside the entry:** A table with columns for 'Function', 'Code / Date of birth', 'Name / business name', and 'Place of residence / seat'.
- Founders:** A table with columns for 'Code / Date of birth', 'Name / business name', 'Place of residence / seat', and 'Contribution'.
- Means of communication:** A table with columns for 'Type' and 'Contents'.
- Planned principal activity:** A field for 'EMTAK' and 'Area of activity'.
- Additional documents to be submitted with the entry petition:** A table with columns for 'ID', 'Type', 'Name', and 'Size'.

At the bottom, there is a 'Check the details of the entry petition' button and contact information for the Centre of Registers and Information Systems.

Schengen and digital signature



- Borders
- Passports
- Cooperation

- E-border guard
- eID
- Cooperation



Demovideo

Certificates we trust

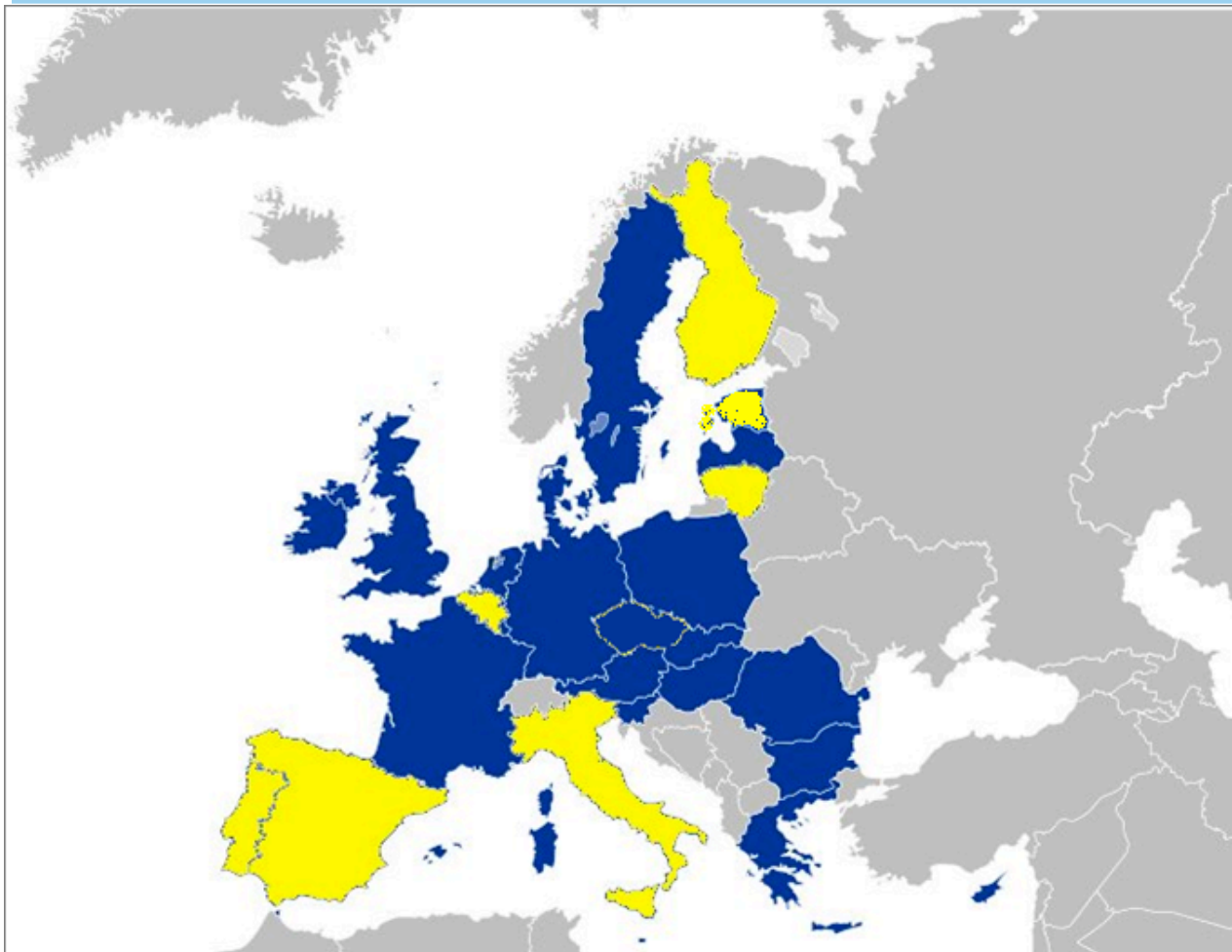

Portugal
Belgium
Finland
Lithuania

...Italy
...Spain

Cross border digital signature



Belgian ID-card Portugese ID-card Finnish ID-card Lithuanian Mobile-ID



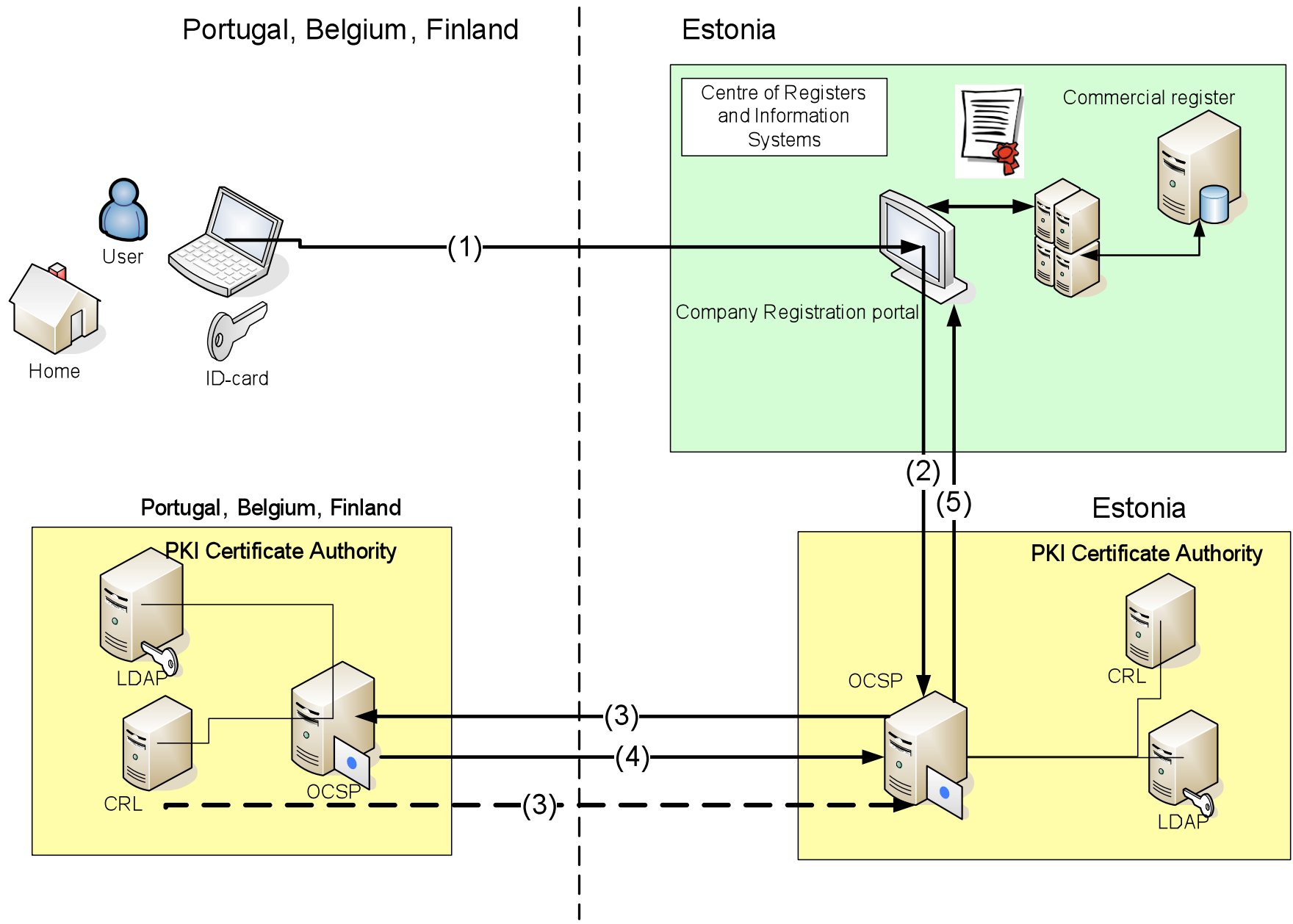

Results



**Saves money, time and
recourses**



First time in Europe



**Beginning of bigger wave of
cross boarder digital signature
acceptance**

Project impacts

- Simplified, clear and guided company registration process- citizen.
- Company registration procedure is much faster!
- Entrepreneurs and citizens can file the documents or register a new legal entity without leaving home or filling in paper forms.
- The technical work of the civil servants has been lessened
 - significantly.
- 45 % of the new companies were registered through CReP in 2009

Cross border impacts

- 1 Company registered
with finnish ID-cards!
- 8 000 000 possible users from EU.
- Annual reports once a year
- Estonian ID and digital signature accepted in
PORTUGAL

www.portaldaempresa.pt



Topics

- Company Registration Portal and PKI, eID
- Cross border digital signature
and Services Directive



Implementation problems

- EBR and future services

Implementation problems

- Legal
 - Some changes in regulation

- Cultural
 - mañana

- Technical
 -

Nation wide ID-card



Belgian ID-card Portugese ID-card Finnish ID-card Lithuanian Mobile-ID



Technical problems

- Qualified digital certificate? Validation?
- [National ID-card? eID](#)
- [Unique personal identification code?](#)
- Time stamping?
- Document format (*.DDOC)?
- PKI standard and readiness

Personal Identification Number



EBR problem



[Company Search](#)

[Official Search](#)

[Direct Reports](#)

Official Search

Please select the country you wish to search and enter your search criteria.

Note: This country may be unavailable

Country * 

Family Name *

First Name

Date of Birth [CCYY] [MM] [DD]

Address

City/County

* - Indicates mandatory field

Submit

Reset





EBR Problem 2

 **English** | [WHAT'S NEW?](#) | [ABC](#)

[Company Search](#) | [Official Search](#) | [Direct Reports](#) | [My Details](#)

Official Search Reply

Country :  [Sweden \(Bolagsverket\)](#)
Request Criteria : **smith - john**
Items Returned : **11 hit(s) delivered.**

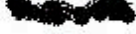
Family / Company Name	First Name	Date of Birth	Country of Birth	Location	Reports
Smith	Charles John			Göteborg	Personal Appointm
Smith	John			GÖTEBORG	Personal Appointm
Smith	David John Allan			Göteborg	Personal Appointm
Smith	John			GÖTEBORG	Personal Appointm
Smith	John Allan			Göteborg	Personal Appointm
Smith	John Anthony			GÖTEBORG	Personal Appointm
Smith	John Anthony			Göteborg	Personal Appointm
Smith	John Thomas Anthony			SIMRISHAMN	Personal Appointm
Smith	John			ARVIKA	Personal Appointm
Smith	Martin John			GÖTEBORG	Personal Appointm
Smith	John			GÖTEBORG	Personal Appointm

EBR Problem 3

Company Search	Official Search	Direct Reports	My Data	
Official Search Reply ⓘ				
Country :	🇧🇪 Belgium (Coface Services Belgium)			
Request Criteria :	Smith - John			
Items Returned :	29 hit(s) delivered.			
<u>Family/Company Name</u>	<u>First Name</u>	<u>Date of Birth</u>	<u>Country of Birth</u>	<u>Location</u>
SMITH JOHN				BRUSSELS
SMITH JOHN				BRUSSELS
SMITH JOHN WILLIAM				BRUSSELS
SMITH JOHN O				
SMITH JOHN WILLIAM				
SMITH DAVID JOHN				BRUSSELS
SMITH JOHN				BRUSSELS
SMITH MICHAEL JOHN				BRUSSELS
SMITH JOHN F				
SMITH JOHN				BRUSSELS

Estonia



e-äriregister

RIK Centre of Registers and Information Systems

CENTRAL COMMERCIAL REGISTER

[Information system](#)

[Simple inquiries](#)

[Detailed inquiry](#)

[Name inquiry](#)

[Trade bans](#)

[New inquiry](#)



Found persons, please choose the right one:

Person	ID code	Date of birth	Location
Jaan Tamm	33711240217		Harju maakond
Jaan Tamm	34106213642		Saarde vald, Pärnumaa
Jaan Tamm	34106214236		Tihemetsa 16-2, Saarde vald, Pärnumaa
Jaan Tamm	34201222739		
Jaan Tamm	34801260275		Tallinn
Jaan Tamm	34801260279	26.01.1948	Nuka, Liiva küla, Muhu vald, Saaremaa
Jaan Tamm	34801260279		Tallinn
Jaan Tamm	35010190227		Viimsi vald, Harjumaa
Jaan Tamm	35011234217		Pärnu
Jaan Tamm	35012272768		Torma vald, Jõgevamaa
Jaan Tamm	35110285225		Rakvere
Jaan Tamm	35606044229		Pärnu
Jaan Tamm	35711070233		Saue vald, Harjumaa
			Tallinn
			Lassi, Tagametsa küla, Saue vald, Harjumaa

Found 29 results. [1](#) [2](#) [Next »](#)

Service activity registration

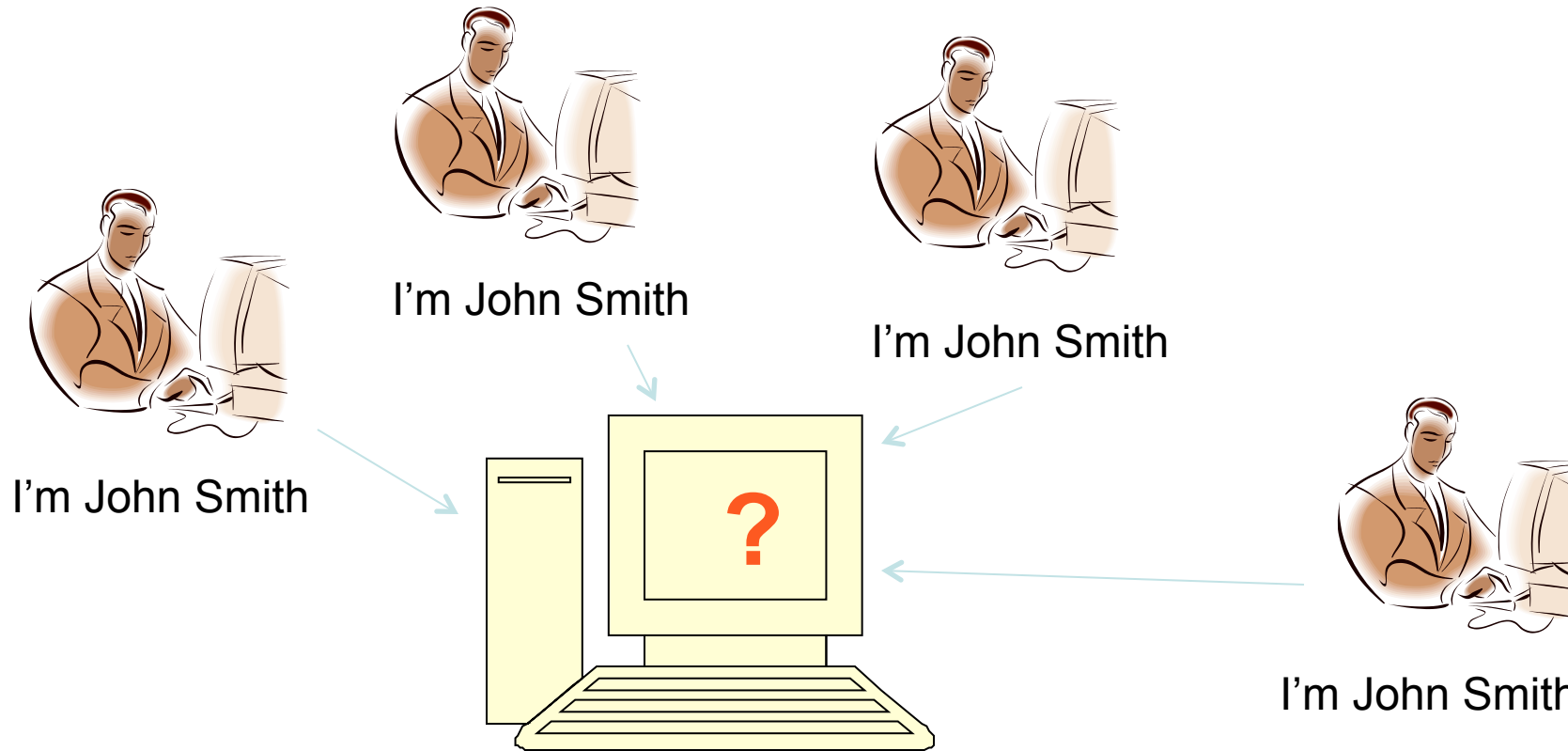

Internet portal:
What company do you represent?

Technical problems

- Qualified digital certificate? Validation?
- [National ID-card? eID](#)
- [Unique personal identification code?](#)
- Document format (*.DDOC)?
- PKI standard and readiness
- Time stamping?

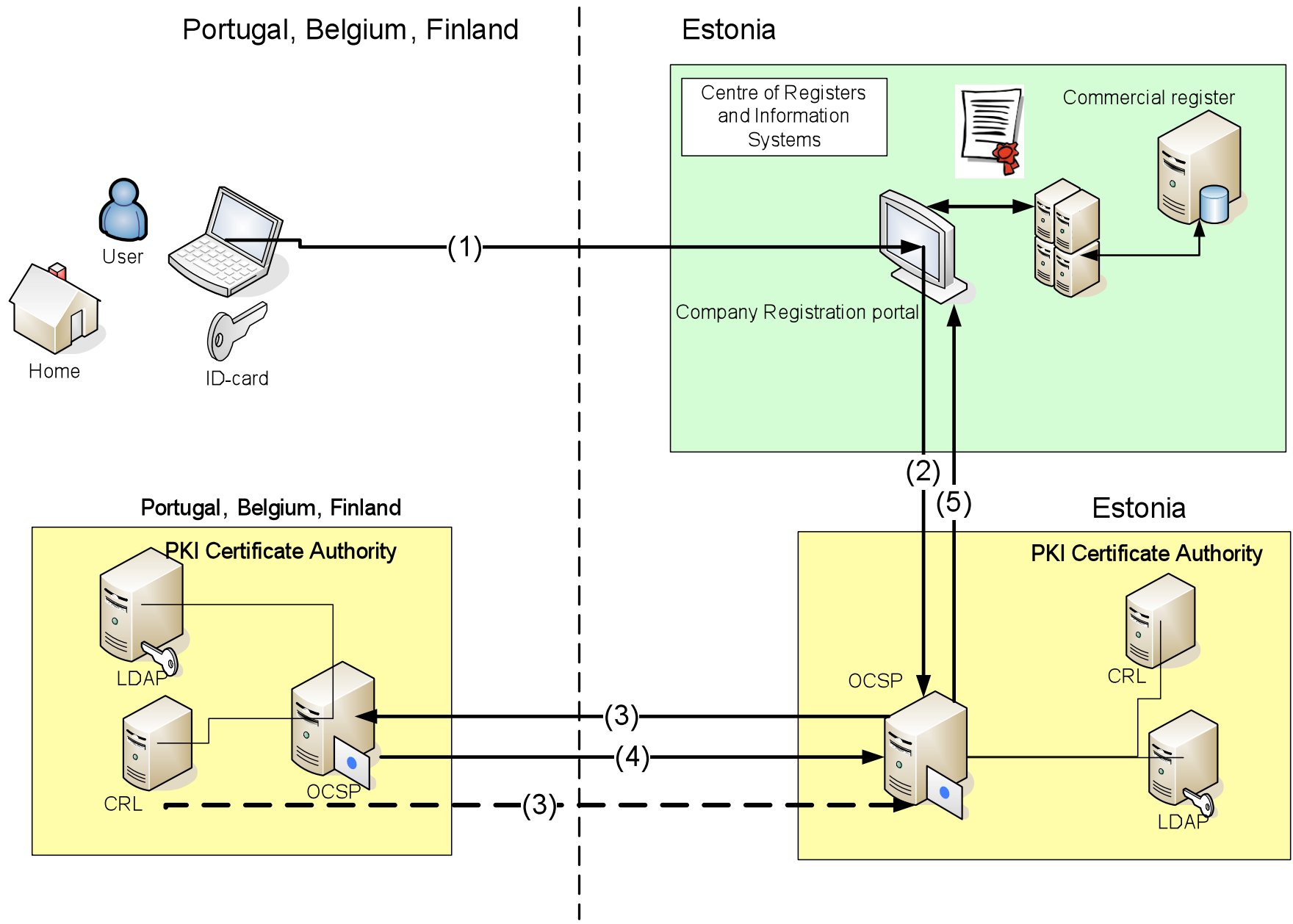

Topics

- Company Registration Portal and PKI, eID
- Cross border digital signature
- Implementation problems



Future services

Business management online

Process

1. Company registration online
2. State fee and share capital online
3. Bank account online 
4. Tax office registration online **FUTURE**
5. License online **FUTURE**
6. Business contracts online!? **FUTURE**
6. Annual report online (XBRL) **2010**

Services Directive 2009

- The Services Directive obliges Member States to ensure by the end of 2009 that service providers are able to complete electronically and at a distance all procedures and formalities necessary to provide a service activity

Needed services: EBR?

- **Right of representation**
- **Role management system**

XML> Input: <Personal number>

XML> Output: <list of companies>;
<and roles in relation>

Conclusion Roadmap

1. Business register (+ personal ID code)
2. Cross border eID and digital signature
3. Representation role services (EBR?)
4. Internal market and Services Directive
5. ...Future business register services...

More information:

- <http://www.epractice.eu/en/cases/crossborderds>
- <http://www.rik.ee/crep>

- Demovideo:
<http://www.youtube.com/watch?v=4hNg5i4i3oU>

https://ettevotjaportaal.rik.ee

e-äriregister
RIK Centre of Registers and Information Systems

COMPANY REGISTRATION PORTAL

To enter the system you will have to authenticate yourself with the ID-card, Mobile-ID or through an internet bank.

NB: Digital signatures can be given only with the ID-card or Mobile-ID!

Authenticate with ID-card or Mobile-ID:

Enter by foreign ID-card or Mobile-ID:

Authenticate through an internet bank:

Support available on business days 9.00-17.00
telephone: 6 696 609
e-mail: rik.ekanded@just.ee

Please find the portal guide [here](#)
[DEMO - Company registration](#)
[DEMO - Filing annual report](#)

Ingmar Vali

ingmar.vali@just.ee